



全国优秀教材二等奖

义务教育教科书

美术

一年级 上册



湖南美术出版社



美术万花筒



外国小朋友的作品
◀ (澳大利亚)

▼ (德国)



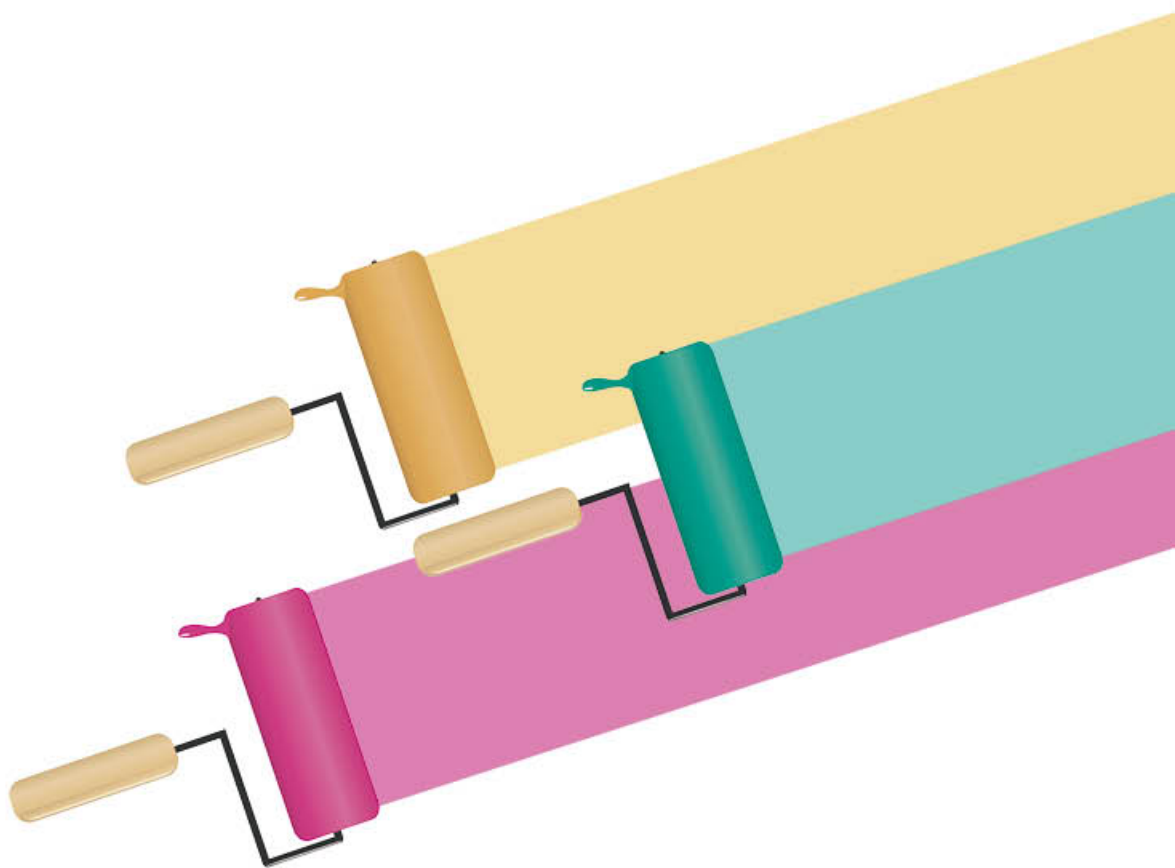

义务教育教科书

美术

一年级
上册

主 编

徐 冰 李小山

副主编

宋子正 黎 丹 刘勉怡 陈卫和 黄 啸 陈淑霞

本册编写人员

张 欣 蔡惠萌 熊 伟 罗 炜 王 琴 郭晓芳

陈 适 文艺芬 何夕岚 颜湘萍 何 娟 彭 敬

习 蓉 曾 瑜 杨群芳 贺佳妮

出版说明

本教材以《中共中央国务院关于深化教育改革，全面推进素质教育的决定》、《国家中长期教育改革和发展规划纲要（2010—2020年）》为指针，依据教育部制定的《义务教育美术课程标准（2011年版）》而编写，是面向全国中小学生进行素质教育的美术课程修订教材。

本教材以促进人的全面发展为出发点，以公民必备的美术知识与技能为基础，注意贴近同学们的学校生活和社会生活，适应同学们的情意和认知要求，强调美术教学过程的情趣性，激发学生的学习兴趣，使之在感受、体验和探究的过程中，掌握学习方法，提高审美感受 and 创新能力，奠定终身学习的基础。

本教材的编写，得到了中央美术学院、首都师范大学、广州美术学院、湖南省教科院、长沙市教科院以及部分美术教师的大力支持和帮助，在此向他们表示衷心的感谢！

目录

- | | | | | | |
|--------|--|----|--------|-------------------------------------|----|
| ■ 第1课 | dà jiā yì qǐ huà
大家一起画 | 2 | ■ 第12课 | biàn liǎn
变脸 | 24 |
| ■ 第2课 | rào rào tú tú
绕绕涂涂 | 4 | ■ 第13课 | qǐng gēn wǒ lái
请跟我来 | 26 |
| ■ 第3课 | tián yě de sè cǎi
田野的色彩 | 6 | ■ 第14课 | yíng yǎng zǎo cān
营养早餐 | 28 |
| ■ 第4课 | dà yǎn jīng
大眼睛 | 8 | ■ 第15课 | wǒ zhǎng gāo le
我长高了 | 30 |
| ■ 第5课 | wǒ de tài yáng
我的太阳 | 10 | ■ 第16课 | shǒu lā shǒu hǎo péng you
手拉手好朋友 | 32 |
| ■ 第6课 | wǒ gēn yuè liang zuò péng you
我跟月亮做朋友 | 12 | ■ 第17课 | jiǎn bǐ huà rén
简笔画人 | 34 |
| ■ 第7课 | qī cǎi fēi hóng
七彩飞虹 | 14 | ■ 第18课 | huà huà huǒ chái rén
画画火柴人 | 36 |
| ■ 第8课 | qí miào de sī zhǐ
奇妙的撕纸 | 16 | ■ 第19课 | mǎ yǐ bān jiā
蚂蚁搬家 | 38 |
| ■ 第9课 | sī zhǐ tiān huà
撕纸添画 | 18 | ■ 第20课 | piào liang de qiān bǐ tóu
漂亮的铅笔头 | 40 |
| ■ 第10课 | wǒ de pīn yīn kǎ piàn
我的拼音卡片 | 20 | ■ 第21课 | niǎo yǔ huā xiāng
鸟语花香 | 42 |
| ■ 第11课 | shù zì biàn biàn biàn
数字变变变 | 22 | ■ 第22课 | xiǎo xiǎo shí pǐn diàn
小小食品店 | 44 |

■ 欣赏·评述

■ 造型·表现

■ 综合·探索

■ 设计·应用



入学谈话 · 赏画 · 大胆涂画

xiǎo péng yǒu huān yíng nǐ
小朋友，欢迎你！

kàn kan huà huà dòng dòng shǒu
看看画画动动手。

xué xí qín xí guàn hǎo
学习勤，习惯好，

jiàn kāng chéng zhǎng duō kuài lè
健康成长多快乐！





xīn shǎng yī xià ba zhè shì gē ge
欣 赏 一 下 吧 ， 这 是 哥 哥

jiě jie de huà ne
姐 姐 的 画 呢 。

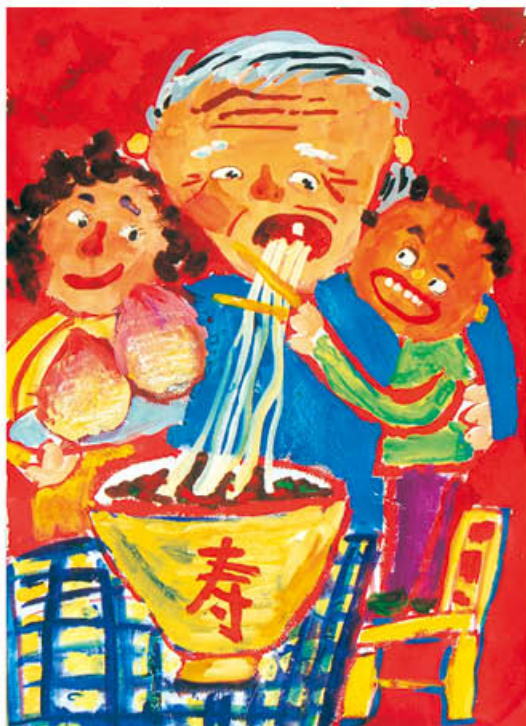

xué sheng zuò pǐn
学 生 作 品

xué xí huó dòng
学 习 活 动

xiǎn zé zì jǐ xǐ huān de huì huà gōng jù zài zhǐ shàng dà dǎn de huà
选 择 自 己 喜 欢 的 绘 画 工 具 ， 在 纸 上 大 胆 地 画 。

xiǎo huā māo zhēn táo qì gǎn zhe xiàn tuán wán yóu xì;
小花猫，真淘气，滚着线团玩游戏；

rào a rào tú a tú biàn chū huà er duō shén qì
绕啊绕，涂啊涂，变出画儿多神气。

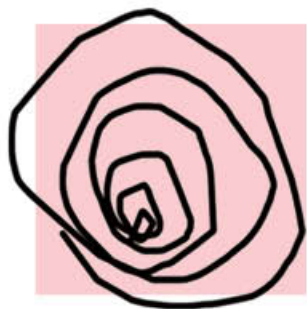

kāi xīn rào
开心绕



jìn qíng tú
尽情涂

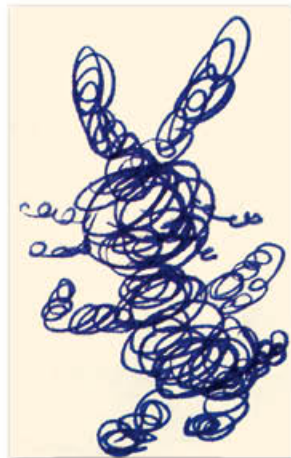
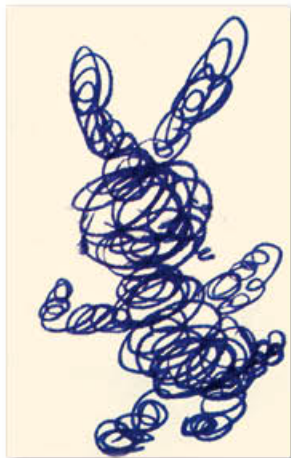



xué shēng zuò pǐn
学 生 作 品



zuò yè wán chéng hòu tào hǎo
作 业 完 成 后 ， 套 好

bǐ mào jiāng huà jù shōu zhěng qí
笔 帽 ， 将 画 具 收 整 齐。

xué xí huó dòng
学 习 活 动

yòng rào tú de huà fǎ huà chū yī gè
用 绕 涂 的 画 法 ， 画 出 一 个

zì jǐ xǐ huān de xíng xiàng
自 己 喜 欢 的 形 象 。



线条分隔色块 · 对比识色

tián yě shàng hóng de hóng huáng de huáng
田野上，红的红，黄的黄，
xiàn xiàn kuài kuài zhēn mí rén kuài kuài bǎ tā huà xià lái
线线块块真迷人，快快把它画下来！



东川红土地（摄影）周日平



nǐ néng shuō chū nǎ jǐ zhǒng yán sè de míng chēng
你能说出哪几种颜色的名称？

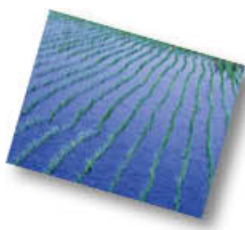



北方九月（套色木刻）现代 晁楣



cān kǎo xià miàn liǎng gè tú
参考下面两个图

lì shì zhe yòng xiàn tiáo fēn gē
例，试着用线条分割

huà miàn zhù yì jìn chù de gé
画面，注意近处的格

zi dà yuǎn chù de gé zi xiǎo
子大，远处的格子小。

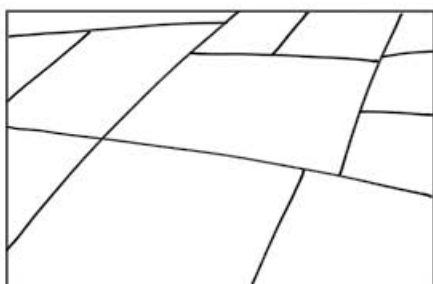
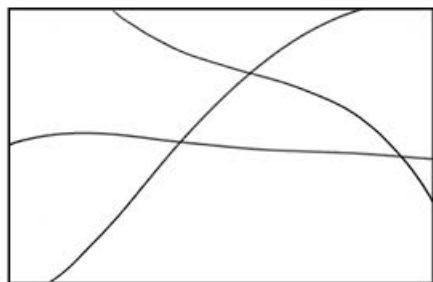

xué shēng zuò pǐn
学生作品



xiāng lín de tián yě yán sè bù
相邻的田野颜色不

tóng tián gēng cái fēn míng
同，田埂才分明。



xué xí huó dòng
学习活动

zài fēn hǎo gé zi de huà zhǐ shàng
在分好格子的画纸上

tú sè huà chū mí rén de tián yě
涂色，画出迷人的田野。

dà dà de yǎn jing kàn shì jiè yǎn zhōng fēng jǐng gèng měi lì 。
大大的眼睛看世界，眼中风景更美丽。



假镜子（油画） 1928

马格利特（比利时）



▶ sì jì de jǐng sè
四季的景色



bù yī yàng yo
不一样哟。

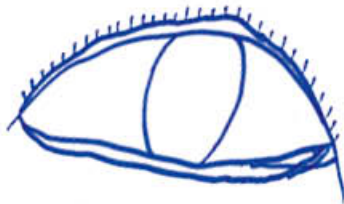

xué xí huó dòng
学 习 活 动

huà yī gè dà yǎn jīng hé xiǎo péng yǒu
画 一 个 “大 眼 睛”，和 小 朋 友

mén shuō yī shuō zì jǐ kàn dào guo de měi lì jǐng wù
们 说 一 说 自 己 看 到 过 的 美 丽 景 物。

bǎ yǎn jīng huà dà cái kě yǐ
把 眼 睛 画 大，才 可 以

zhuāng xià měi lì de jǐng sè
装 下 美 丽 的 景 色。



太阳神鸟金饰 商代
四川金沙遗址出土

yuán yuán de tài yáng biǎo qíng hěn
圆 圆 的 太 阳 ， 表 情 很

duō yàng xiào de xiào chóu de chóu
多 样 。 笑 的 笑 ， 愁 的 愁 ，

wǒ huà de tài yáng zuì piào liang
我 画 的 太 阳 最 漂 亮 ！





tài yáng shì gè ài piào liang de gū niang
太阳是个爱漂亮的姑娘



tài yáng kǎo de wǒ hǎo rè a
太阳烤得我好热啊



tài yáng wá wa yào shuì jiào le
太阳娃娃要睡觉了

xué sheng zuò pǐn
学生作品

xué xí huó dòng
学习活动

huà yī huà zì jǐ
画一画自己

xiǎng xiàng zhōng de tài yáng
想象中的太阳。

wǒ gēn yuè liang zuò péng you
我跟月亮做朋友

月亮的变化·突出主体形象

yuè liang zǒu wǒ yě zǒu wǒ gēn yuè liang zuò péng you
月亮走我也走，我跟月亮做朋友。



绘画 雷雨可



yuè liang shì gè xiǎo táo qì tiān tiān dōu yǒu xīn biàn huà
月亮是个小淘气，天天都有新变化。





yuè liang yāo qǐng wǒ
月亮邀请我

cān jiā wǎn huì wǒ gāi zěn
参加晚会，我该怎

me dǎ ban ne
么打扮呢？



xué shēng zuò pǐn
学生作品



xué xí huó dòng
学习活动

shuō shuō nǐ hé yuè liang de gù shì bǎ nǐ de xiǎng fǎ huà xià lái
说说你和月亮的故事，把你的想法画下来。

认识七种基本颜色



yǔ guò tiān qíng wá wa xiào
雨过天晴娃娃笑，

hóng chéng huáng lǜ lán diàn zǐ
红橙黄绿蓝靛紫，

yī cì jià qǐ cǎi hóng qiáo
依次架起彩虹桥。



cǎi hóng li de yán sè nǐ néng yī cì huà chū jǐ zhǒng
彩虹里的颜色你能依次画出几种？





翁弗勒港口（油画） 1899 西涅克（法国）



xué sheng zuò pǐn
学生作品



xué xí huó dòng
学习活动

zhǎo chū hé cǎi hóng xiāng sì de yán sè huà yī fú yǒu cǎi hóng de měi lì tú huà。
找出和彩虹相似的颜色，画一幅有彩虹的美丽图画。

cǎi sè xiǎo zhǐ piàn sī tiē biàn biàn biàn
彩色小纸片，撕贴变变变。



国王的悲伤(剪贴画) 1952 马蒂斯(法国)





sī chū dà xíng
撕出大形



sī chū xiǎo xíng
撕出小形



shǒu zhǐ kào jìn gèng hǎo sī
手指靠近更好撕

shì yī shì sī chū zhí biān hé wān biān de zhǐ
试一试，撕出直边和弯边的纸

tiáo liàn xí zěnyàng kòngzhì sī de fāngxiàng
条，练习怎样控制撕的方向。



xué shēng zuò pǐn
学生作品



sī tiē wán chéng hòu shōu shì
撕贴完成后收拾

hǎo suì zhǐ piàn
好碎纸片。

xué xí huó dòng
学习活动

sī tiē chū zì jǐ xǐ huān de xíng xiàng
撕贴出自己喜欢的形象。

sè zhǐ suí yì sī tiān huà biàn mú yàng
色纸随意撕，添画变模样。



大房间(剪贴画) 1988 霍克尼(英国)

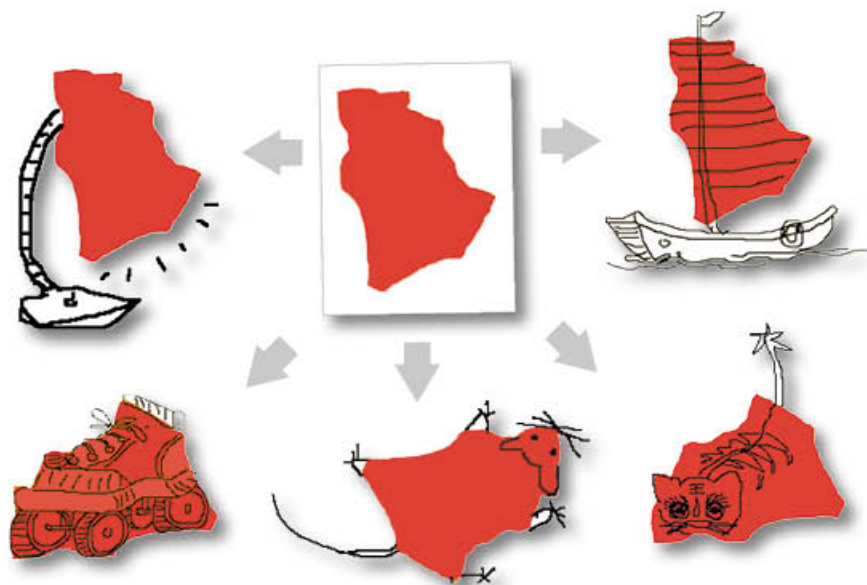

yòng yī zhāng xiǎo
用一张小

cǎi sè zhǐ biàn chū hǎo
彩色纸变出好

jǐ gè xíng xiàng lái nǐ
几个形象来。你

zhī dào zěn me biàn ma
知道怎么变吗?



wài bù tiān huà
外部添画



nèi bù tiān huà
内部添画



xué shēng zuò pǐn
学生作品



xué xí huó dòng
学习活动

zhuàn dòng sī xià de xiǎo zhǐ piàn kàn kan tā xiàng shén me bǎ tā zhān tiē zài zuò
转动撕下的小纸片，看看它像什么，把它粘贴在作

yè zhǐ shàng tiān huà chéng yǒu qù de xíng xiàng
业纸上，添画成有趣的形象。

★ 第 10 课

wǒ de pīn yīn kǎ piàn
我的拼音卡片

剪规定形·装饰字母

a o e, i u ü,
wǒ gěi pīn yīn chuān huā yī
我给拼音穿花衣!





xiū jiǎn kǎ piàn de sì jiǎo
修剪卡片的四角

hé sì biān kǎ piàn de wài xíng
和四边，卡片的外形

huì yǒu fēng fù de biàn huà
会有丰富的变化。

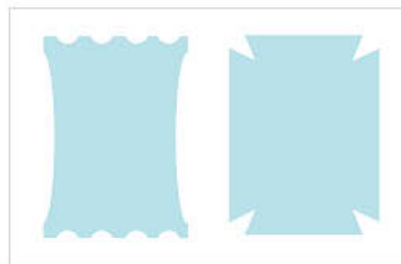

xué shēng zuò pǐn
学生作品



xué xí huó dòng
学习活动

xuǎn zé zì jǐ xǐ huan de fāng fǎ zuò zhāng pīn yīn kǎ piàn rán hòu hé xiǎo
选择自己喜欢的方法做张拼音卡片，然后和小

péng yǒu men wán wán pīn yīn yóu xì
朋友们玩玩拼音游戏。



第 11 课

shù zì biàn biàn biàn

数字变变变

字形的联想·相似形

xiǎng fǎ bù tóng biàn huà qí

1 2 3 4 5 6 7, 想法不同变化奇。

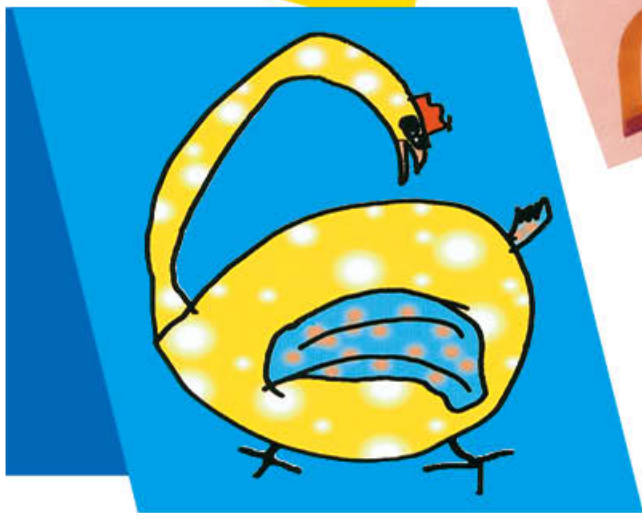

kàn kan xià miàn zhè xiē tú piàn

看看下面这些图片，

nǐ xiǎng dào le nǎ xiē shù zì

你想到了哪些数字？



tóng yī gè shù zì bù
同一个数字，不

tóng de dǎ ban kě yǐ biàn chū
同的打扮，可以变出

bù tóng de xíng xiàng
不同的形象。

xué shēng zuò pǐn
学生作品



肖像（新媒体艺术）现代 张骏

xué xí huó dòng
学习活动

yī qǐ wán wán shù zì biàn biàn biàn
一起玩玩“数字变变变”，

kàn kàn shéi de xiǎng fǎ qí shéi de diǎn zi duō
看看谁的想法奇，谁的点子多。

★ 第 12 课 biàn liǎn 变 脸

折纸识图·依形添画

xiǎo zhǐ zhé hòu huà bǐ miào ,
小 纸 折 后 画 笔 描 ,
biàn huà duō duān zhēn zhèng miào 。
变 化 多 端 真 正 妙 。



zhé hén yào míng xiǎn biān jiǎo yào duì qí
折 痕 要 明 显 , 边 角 要 对 齐 。

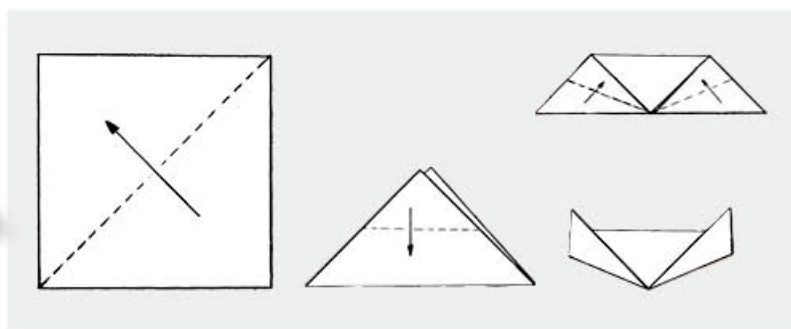



xué shēng zuò pǐn
学 生 作 品



mó fǎng zhè xiē biǎo qíng tǐ
模 仿 这 些 表 情 ， 体

huì yī xià bù tóng de xīn qíng
会 一 下 不 同 的 心 情 。



wāng wāng
汪 汪 ……



xué xí huó dòng
学 习 活 动

zhé zhe huà huà wán wán biàn liǎn de yóu
折 折 画 画 ， 玩 玩 变 脸 的 游

xì shuō shuō zì jǐ de xiǎng fǎ
戏 ， 说 说 自 己 的 想 法 。

★ 第 13 课 qǐng gēn wǒ lái
请 跟 我 来

撕剪成形·联想添画



tù zǐ guāi ya guāi
兔 子 乖 呀 乖 ，
páng xiè qián zhāng kāi
螃 蟹 钳 张 开 。
wǒ dòng nǐ yě dòng
我 动 你 也 动 ，
qǐng nǐ gēn wǒ lái
请 你 跟 我 来 。





wān wān xiǎo mǔ zhǐ
弯弯小拇指，

tā jiù gēn wǒ diǎn tóu xiào
它就跟我点头笑。

xué shēng zuò pǐn
学生作品



zhèng miàn
正面



bèi miàn
背面



xué xí huó dòng
学习活动

sī jiǎn yī gè dòng wù zhí wù huò rén wù de xíng
撕、剪一个动物、植物或人物的形

zhuàng ràng tā de mǒu yī gè huò liǎng gè bù fēn dòng qǐ lái
状，让它的某一个或两个部分动起来。

第 14 课 yíng yǎng zǎo cān 营 养 早 餐

制作表格 · 画简单形

gǔ lèi tiān néng liàng dàn bái yǒu yíng yǎng
谷类添能量，蛋白有营养，
shū guǒ bù néng shǎo yǐn shí yào jiàn kāng
蔬果不能少，饮食要健康。

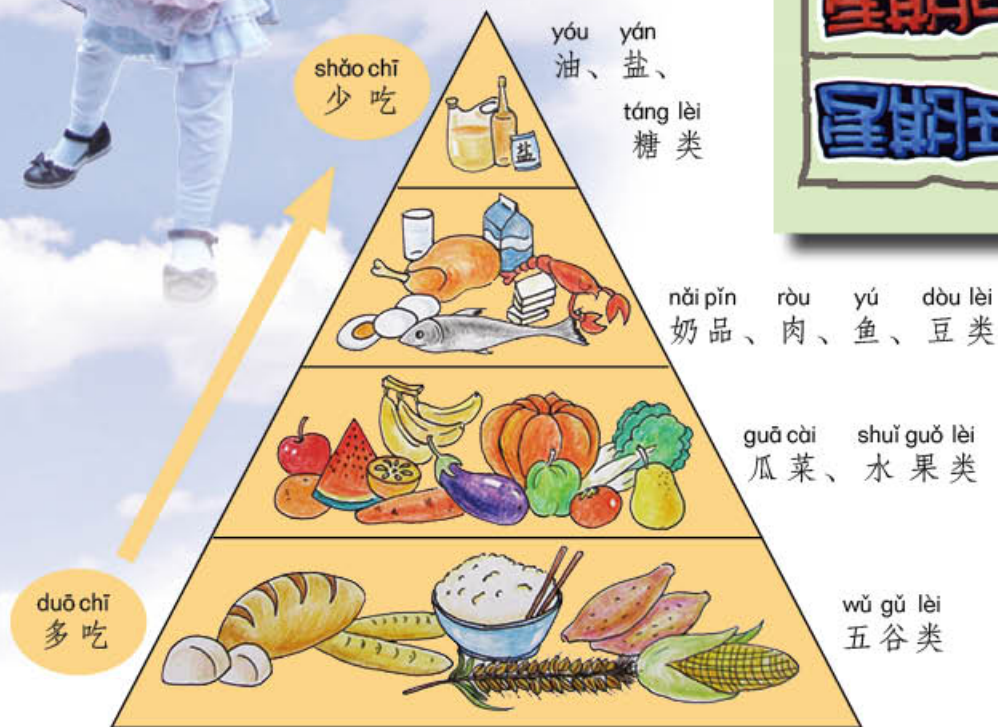

jiàn kāng yǐn shí jīn zì tǎ
健康饮食金字塔



	主食类
星期一	
星期二	
星期三	
星期四	
星期五	

早餐搭配表

液体食物	蔬果类	其他
		
		
		
		
		



gěi xià liè shí wù tián shàng hé
给下列食物填上合

shì de yán sè
适的颜色。

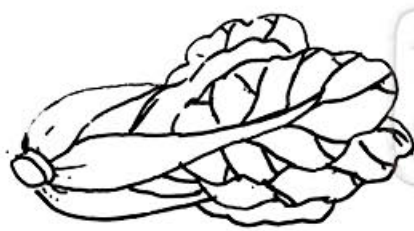

请在作业
纸上完成

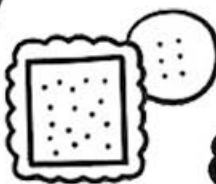

xué xí huó dòng
学习活动

bǎ zì jǐ xǐ huān de zǎo cān huà zài shí pǔ biǎo li kàn kàn shì fǒu yíng yǎng yòu jiàn kāng
把自己喜欢的早餐画在食谱表里，看看是否营养又健康。

★ 第 15 课 wǒ zhǎng gāo le 我长高了

感受成长 · 描画细节

kù zi duǎn le xié zi xiǎo le;
裤子短了，鞋子小了；

wǒ zhǎng gāo le bà mā xiào le。
我长高了，爸妈笑了。



★ xiǎng yī xiǎng shuō
想一想，说

yī shuō wǒ men zhǎng gāo
一说，我们长高

hòu shēng huó fā shēng le
后，生活发生了

nǎ xiē biàn huà?
哪些变化？



xué shēng zuò pǐn
学生作品

xué xí huó dòng
学习活动

nǐ zěn me zhī dào zì
你怎么知道自

jǐ zhǎng gāo le ne xiǎng
己长高了呢？想

xiǎng zì jǐ de shēng huó
想自己的生活

jīng lì bǎ zhǎng gāo hòu
经历，把长高后

de biàn huà hé xīn qíng huà
的变化和心情画

xià lái。
下来。



★ 第 16 课 shǒu lā shǒu hǎo péng you 手拉手好朋友

人物动态的呼应



世界各族人民大团结（壁画）

现代 周令钊

shǒu lā shǒu
手拉手，
yī qǐ zǒu
一起走。

tóng yóu xì
同游戏，
hǎo péng you
好朋友。





xiǎng yī xiǎng hái
想 一 想 还

yǒu nǎ xiē shǒu lā shǒu
有 哪 些 手 拉 手

de yàng zi
的 样 子。



xué xí huó dòng
学 习 活 动

huà zì jǐ hé hǎo péng you
画 自 己 和 好 朋 友

zài yì qǐ wán shuǎ de qíng jǐng
在 一 起 玩 耍 的 情 景。

★ 第 17 课 jiǎn bǐ huà rén 简笔画人

画人物动态

yī gè xiǎo quān quān jǐ tiáo cháng duǎn xiàn
一个小圈圈，几条长短线，

jiǎn bǐ huà rén wù zī tài gè bù tóng
简笔画人物，姿态各不同。



村落图 云南沧源岩画

yòng tuǒ yuán xíng biǎo shì tóu bù zhí xiàn biǎo shì shēn qū hé sì zhī
用椭圆形表示头部，直线表示身躯和四肢。



huà tóu
画头



huà shēn qū
画身躯



huà xià zhī
画下肢



huà shàng zhī
画 upper 肢

yùndòng zhōng de rén qū gàn hé
运动中的人，躯干和

sì zhī huì yǒu biànhuà
四肢会有变化。

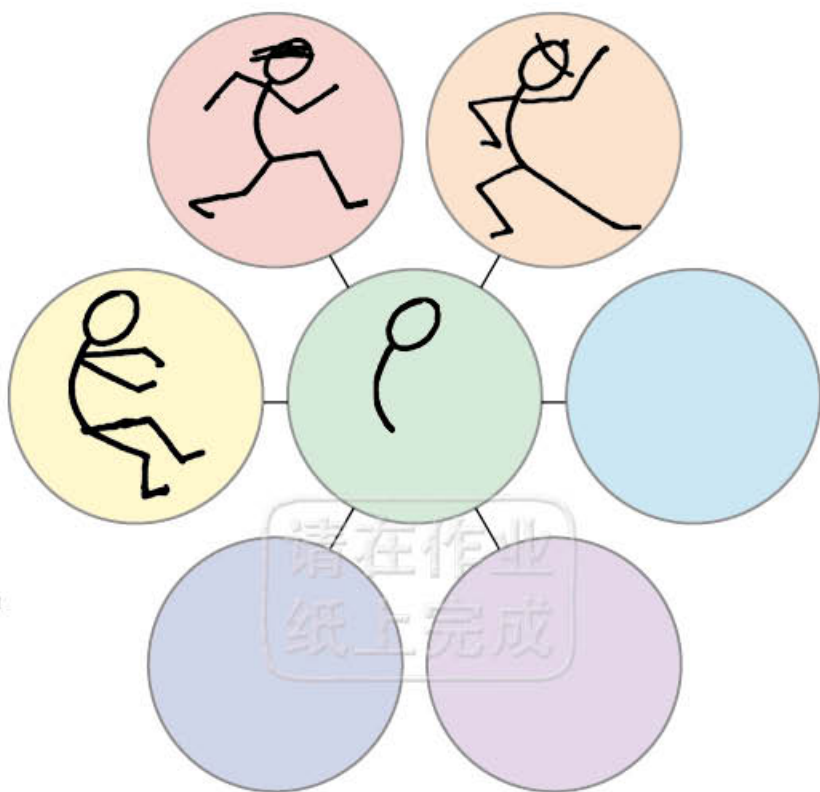
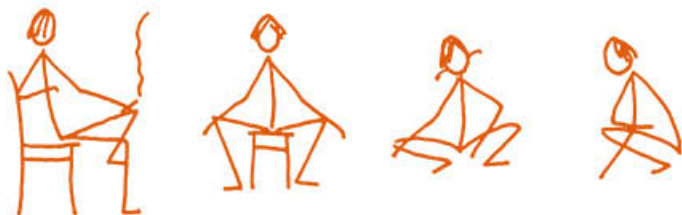

fǎngzhào yòu tú tiānhuàsān
仿照右图，添画三

gè bù tóng de dòngzuò
个不同的动作。

xué xí huódòng
学习活动

guānchá cūnlù tú shuō shuō zhè xiē rén zài zuò shén me yòng jiǎn bǐ
观察《村落图》，说说这些人在做什么。用简笔

huà de fāng fǎ huà yī huà zì jǐ gǎnxìng qù de rén wù dòng zuò
画的方法画一画自己感兴趣的人物动作。

★ 第 18 课 huà huà huǒ chái rén 画画火柴人

画画场景组合

huǒ chái rén zhēn shén qì niǔ yāo fān gǔn yǒu huó lì
火柴人，真神气，扭腰翻滚有活力。

huá huá xuě yóu yóu yǒng kuài lái yì qǐ wán yóu xì!
滑滑雪，游游泳，快来一起玩游戏！



zài rén wù zhōu wéi
在人物周围

tiān huà jǐng wù huà miàn
添画景物，画面

gèng wán zhěng
更完整。





xué shēng zuò pǐn
学 生 作 品

zài xià biān chǎng jǐng zhōng tiān
在 下 边 场 景 中 添

huà rén huò rén zhù yì ān pái
画 3 人 或 5 人 ， 注 意 安 排

hǎo tā men de wèi zhì
好 他 们 的 位 置 。

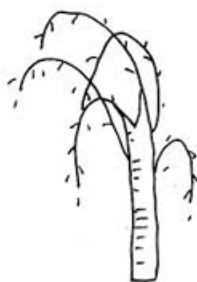
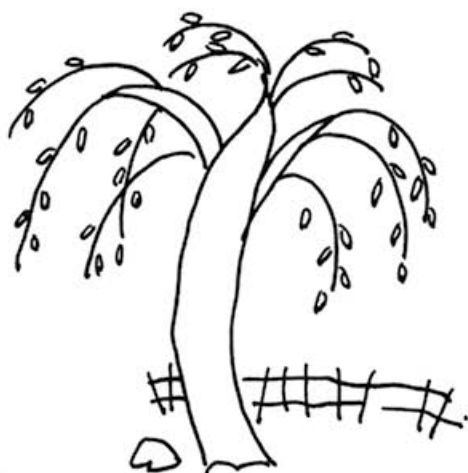

请 在 作 业
纸 上 完 成

xué xí huó dòng
学 习 活 动

xiǎng xiǎng huǒ chái rén jù zài yì qǐ kě yǐ zuò xiē shén me yǒu qù de shì qing
想 想 火 柴 人 聚 在 一 起 可 以 做 些 什 么 有 趣 的 事 情 ，

huà huà tā men huó dòng de chǎng jǐng
画 画 他 们 活 动 的 场 景 。

第 19 课 mǎ yǐ bān jiā 蚂蚁搬家

形体结构 · 动态组合

hōng lōng lōng kā chāchā
轰隆隆， 咔嚓嚓，

diàn shǎn léi míng jiào rén pà
电闪雷鸣叫人怕，

mǎ shàng jiù yào xià yǔ la
马上就要下雨啦，

xiǎo mǎ yǐ ya kuài bān jiā
小蚂蚁呀快搬家。



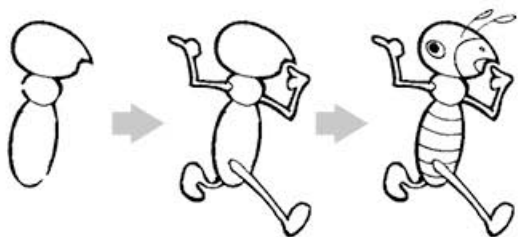

cháng shì bǎ xià tú zhōng de sān zhī
尝试把下图中的三只

mǎ yǐ tiān huà wán zhěng。
蚂蚁添画完整。



蚂蚁搬家之三（油画）2006 张小涛



请在作业
纸上完成

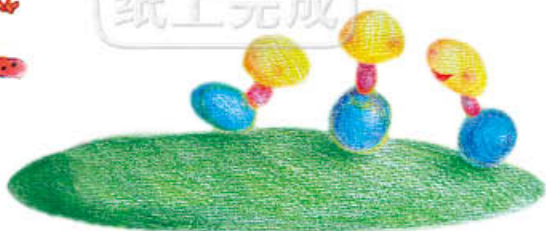

xué shēng zuò pǐn
学生作品



xué xí huó dòng
学习活动

xiǎo mǎ yǐ huì zěn
小蚂蚁会怎

yàng bān jiā ne bǎ nǐ
样搬家呢？把你

de xiǎng fǎ huà xià lái。
的想法画下来。

★ 第20课 piào liang de qiān bǐ tóu 漂亮的铅笔头

搓、揉泥·粘贴、装饰

xiǎo xiǎo qiān bǐ ài dǎ ban
小小铅笔爱打扮，
dài dǐng mào zi gèng hǎo kàn
戴顶帽子更好看。





shì shì yòng cǎi ní róu chū yī gè shì
试试用彩泥揉出一个适

hé qiān bǐ tóu de xiǎo yuán qiú 。
合铅笔头的小圆球。



铅笔头（雕塑）现代

盖蒂（美国）



zuò wán zuò yè hòu jiāng
做完作业后，将

xiāng tóng yán sè de cǎi ní róu chéng
相同颜色的彩泥揉成

tuán shōu hǎo
团收好。

xué xí huó dòng
学习活动

yòng cǎi ní huò qí tā shì hé de cái
用彩泥或其他适合的材

liào zuò gè yǒu qù de qiān bǐ tóu kàn shéi zuò
料做个有趣的铅笔头。看谁做

de shēng dòng yǒu qù fù yǒu chuàng yì
得生动有趣、富有创意！



第21课 niǎo yǔ huā xiāng 鸟语花香

头饰制作与装饰

huār ài tài yáng niǎor ài lán tiān
花儿爱太阳，鸟儿爱蓝天。

wǒ men ài huā niǎo niǎo yǔ yòu huā xiāng
我们爱花鸟，鸟语又花香。



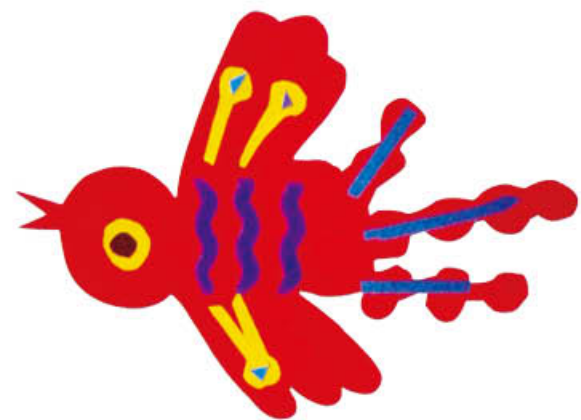

xué xí huó dòng
学 习 活 动

dài shàng zì jǐ zhì zuò de huā huò
戴 上 自 己 制 作 的 “ 花 ” 或

niǎo dà jiā yì qǐ zuò yóu xì
“ 鸟 ” ， 大 家 一 起 做 游 戏 。

★ 第 22 课 xiǎo xiǎo shí pǐn diàn 小小食品店

泥的揉、搓、压、捏、拼·团形·模拟活动

ní bā tuánr shǒu zhōng niē yòu cuō yòu yā pán quān quān
泥巴团儿手中捏，又搓又压盘圈圈。

zuò le táng guǒ zuò gāo diǎn kāi gè xiǎo xiǎo shí pǐn diàn
做了“糖果”做“糕点”，开个“小小食品店”。





nǐ zhī dào zhè xiē shí
你知道这些食

pǐn de jià gé ma
品的价格吗?



tiáo
条



kuài
块



qiú
球



zhù
柱



xué xí huó dòng
学习活动

yòng táo ní huò cǎi ní zuò shí pǐn bǎi zài yì qǐ kāi gè xiǎoxiǎoshí pǐndiàn
用 陶泥或彩泥做“食品”，摆在一起，开个“小小食品店”。

图书在版编目 (CIP) 数据

美术. 一年级. 上册 / 徐冰, 李小山主编. —长沙:
湖南美术出版社, 2012. 5
义务教育教科书
ISBN 978-7-5356-5401-4

I. ①美… II. ①徐… ②李… III. ①美术课—小学—
教材 IV. ①G624. 751

中国版本图书馆CIP数据核字(2012)第093221号

义务教育教科书 美术 一年级 上册

湖南美术出版社 编
现代美术教育研究所

主 编: 徐 冰 李小山

责任编辑: 王春林

封面设计: 戴 宇

责任校对: 徐 盾

出 版: 湖南美术出版社

(长沙市东二环一段 622 号)

重 印: 湖南出版中心

发 行: 湖南省新华书店

印 刷: 湖南天闻新华印务有限公司

开 本: 787 X 1092 1/16

印 张: 3

版 次: 2022年6月第1版第11次印刷(2022秋)

印 数: 1-120 000 册

书 号: ISBN978-7-5356-5401-4

定 价: 8.89 (含课堂练习册)

著作权所有, 请勿擅用本书制作各类出版物, 违者必究。
如有质量问题, 影响阅读, 请与湖南出版中心联系调换。
联系电话: 0731-88388986 0731-88388987

使用记录

教科书登记号

_____ 省（市、自治区）

_____ 市（州）

_____ 市（县、区）

_____ 学校

教科书状况

班级

签名

时间

领 取

归 还

- 学生不能在本教科书其他任何地方签名或者做标记！
- 教师应能在签名处看到学生清晰的签名。
- 在教科书状况栏中请使用以下词语：新、良好、一般、较差、损坏。



合阳面花

